

Article number: 021816011208

Description: Clamp with bracket and rubber  
SPGU 6011. 208/30 SK

## Measures

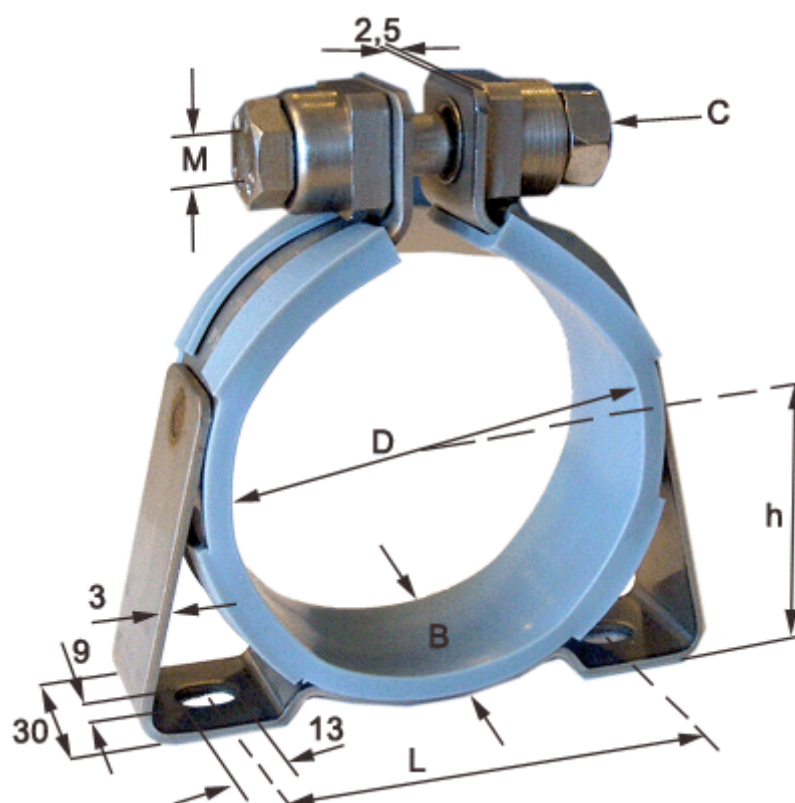

C (screw type) = SK hexagon screw

Diameter D = 208

h = 113

L = 212

Width B = 30